

OFF ROAD

GENERAL REQUIREMENTS

Modified Article	Date of Application	Date of Publication
Article 5 (d)	10/10/2022	10/10/2022

1. DEFINITIONS

All vehicles shall comply with the definition of an automobile, i.e., a land vehicle propelled by its own means, running on at least four wheels not in a line which must be normally in contact with the ground and of which at least two must effect the steering and at least two the propulsion; save that Motorsport Australia' jurisdiction extends also to "All Terrain Vehicles" which are not required to comply with the foregoing definition.

2. FIREWALL

Each vehicle must be fitted with an effective firewall which must separate the occupant/s from the fuel tank and from the engine. With the occupant/s seated in a normal position, the fuel tank must not be visible, whether fore or aft of the passenger compartment.

3. PROTECTION

- (a) Each vehicle shall be so constructed that the occupant/s are protected from the entry of foreign matter into the driving compartment from the road and/or road wheels by the provision of an adequate floor pan and coachwork. Floor plates shall be a minimum thickness of 1.5mm steel or 2.0mm aluminium, secured by bolts a minimum size of 6mm or 1/4 turn fasteners; e.g., Dzus. Any series production vehicle retaining the original floor pan is exempt from this requirement.
- (b) Further, all vehicles shall be equipped with a transmission system so arranged that the propeller shaft and universal joints, if passing through or beneath the passenger compartment, shall be under the floor pan, or fitted in tubes or casings. Such floor pans, tubes or casings shall not be of a temporary nature but shall be joined and firmly fixed to the coachwork or chassis. Any chains used in the transmission of power or for driving any auxiliary component shall be effectively guarded.
- (c) Where any engine and/or gearbox/automatic transmission intrudes into the crew area or, in Performance 2WD and Extreme 4WD, has resulted in any modification of the firewall, it must be fitted with a steel bell-housing or scatter shield complying with the provisions of Schedule M (see "General Requirements for Cars and Drivers" in the Motorsport Australia Manual).

4. TAILSHAFT

Be fitted with a device or devices that shall protect any longitudinal propeller shaft from striking the ground in the event of a component failure.

5. FUEL TANK/S

- (a) Where fuel tanks are exposed to rearward impact, in any class of vehicle, and not protected by chassis structure, they are to fit a protection structure in accordance with the following diagram.
- (b) A vehicle subject of a log-book prior to 30 June 2018, steel tubing of dimensions not less than OD 25mm x 2.5mm thickness, or 30mm x 1.6mm shall be used in the construction of the protection structure. For a vehicle subject of a log-book from 1 January 2019, steel tubing must be at least OD 38.1mm x 2.5mm thickness.

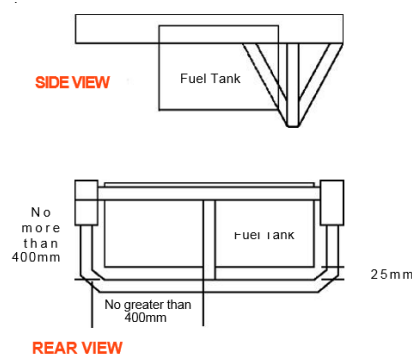

- (c) A Pro, Prolite, Sportslite, Super 1650, or Sportsman buggy, which is fitted with a side mounted fuel tank/s shall be entirely inboard of the deflection (nerf) bars.
- (i) For a vehicle subject of a Log Book prior to 1 March 2015, the deflection (nerf) bar/s shall be made from tubing with the following minimum OD 30 mm x 1.6 wall thickness.
 - (ii) For a vehicle subject of a Log Book after 1 March 2015, the deflection (nerf) bar/s shall be made from tubing with the following minimum OD 38.1 mm x 2.5 mm thickness.
- (d) Each fuel tank must be vented to the atmosphere, externally to the coachwork. The vent pipe must be located on the upper surface of the tank and as close as possible to a corner. A tube of at least 8mm diameter must rise above the tank a distance at least equal to the deepest dimension of the tank; be so arranged that it crosses the tank to the side opposite that of entry; and be directed downwards to a point at least 150mm below the lowest point of the tank.

All fuel tanks must be fitted with a leak-proof filler cap.

Each fuel tank filler (including any filler neck/lines) must not protrude from the coach/bodywork of the Automobile and must be located within the structure of the chassis or safety cage structure.

It is highly recommended that a filler neck be fitted with a non-return valve (i.e. a type with one or two sprung "flaps" or where suitable, a gravity activated style valve) in a location nearest to the fuel tank.

The filler neck is defined as being the means used to connect the fuel tank to the fuel filling location if separate to the fuel tank itself. A fuel cap directly attached to/integrated with the fuel tank is not considered a filler neck. Non-return valves are highly recommended in all applications.

NOTE: filler neck non-return valves will be mandatory from 1 January 2023.

- (e) As an alternative to a vent pipe, a suitable non-return valve may be fitted to the top surface of the fuel tank. Fuel tank capacity is free. It is strongly recommended that fuel-cell foam be used in all fuel tanks.

6. REVERSE GEAR

Each vehicle must be fitted with an operable reverse gear.

7. REAR VISION

- (a) Each vehicle shall be fitted with at least two rear vision mirrors each of which must have a reflecting surface of at least 50cm², and which must provide unobstructed view to the rear of the car for the driver or, where applicable, the passenger.
- (b) A rear vision camera system may be used in place of rear vision mirrors.

8. TOWING POINTS

Each vehicle shall be fitted with readily accessible towing points at front and rear, one forward of the front axle, and the other rearward of the rear axle, such to be distinctively coloured bright red or marked with the word TOW. If in the form of an "eye" they shall have an internal diameter of not less than 40mm.

9. CHASSIS/FRAME/BODYWORK

9.1 GENERAL REQUIREMENTS

- (a) Frames complying with these regulations and the specific class regulations shall be eligible for Motorsport Australia Off Road competition.
- (b) Construction, and in particular welding, must be to recognised industry standards. Unsatisfactory construction could result in an application for a log book being refused, and/or not passing scrutiny at an event.
- (c) Due to the extremely wide variety of off road vehicle designs, the minimum requirements for frames relate primarily to the compartment within which the crew shall be accommodated, and thus the protection of the occupants. Material and design of other aspects of chassis design not specifically referred to or controlled by these regulations, or the Off Road GRs or SRs, are free. However, design should always take into account crew safety.

- (d) Any frame constructed of high carbon heat-treated steel tubes (e.g., chromoly) of less than 38mm x 2.4mm shall be subject of Motorsport Australia Safety Cage Certification, and this documentation must be available at scrutiny or the vehicle may not be permitted to start.
- (e) Each vehicle must be subject of an inspection by a Motorsport Australia approved pre log book scrutineer prior to the issue of a Motorsport Australia log book.
- (f) Any automobile where the rear wheels are not adequately protected by bodywork, must be fitted with deflection (nerf) bars. These are to be constructed from metal, mounted externally on the frame and must extend to at least the outer extremity of the rear tyre tread. They are to be braced at a third point which is between, but not collinear with, the two end mounting points. The overall length between the front and rear mounting points of such bars shall be not less than 800mm. The tube must be at least OD 30mm x 1.6mm wall thickness.
- (g) Any Extreme 2WD and Extreme 4WD automobile which utilises a production floor pan (e.g., Extreme 2WD Baja) may continue to comply with Article 18.
- (h) Each Extreme 2WD, Performance 2WD, Production 4WD and Extreme 4WD automobile (except where provided for by Specific Requirements) must be fitted with full bodywork of a style commercially available from the vehicle manufacturer. The use of chassis/cab vehicles without rear bodywork, and of tray-top vehicles, is prohibited.
- (i) A vehicle which is subject of a Motorsport Australia log book issued prior to 1 January 1998 may continue in competition provided it remains in conformity with the regulations that were in force up to that date, except that it shall comply with the requirement for roof reinforcement outlined in Article 9.7 and the side protection requirements outlined in Article 9.2(ii) and 9.6(a) of the regulations. Any other automobile utilising the provisions of Article 9 is required to be in compliance with this regulation in its entirety.
- (j) A buggy which is subject of a Motorsport Australia log book issued prior to 1 January 1998 that is the subject of an Off Road class change, due to an increase to its engine capacity, to either Pro-lite or Pro class, must be fitted with a Safety Cage Structure compliant with the minimum requirements of the current GR9. In such case the change to the Off Road class must be noted by Motorsport Australia in the Motorsport Australia Log Book for that vehicle. Omissions or design variations to the minimum requirements of the current GR9 are not permitted without the specific approval of Motorsport Australia, and the required notation in the Motorsport Australia log book for that vehicle.
- (k) Each frame shall comply with the following:
 - (i) The frame must be designed and made so that it substantially reduces deformation of the cockpit space in a collision and therefore reduce the risk of injury to occupants.
 - (ii) Each joint shall be welded and the weld shall extend around the entire perimeter of the tube.
 - (iii) "Gusseting" of tube joins is permitted, and in the case of side protection bars joined in an "X" configuration, gusseting is highly recommended.
 - (iv) Where two sections of tubing are butt welded together the joint must be sleeved with the sleeve engaging each side of joint by 2 times the diameter of tubing and each tube drilled and plug welded.
 - (v) Tubes forming part of the chassis/frame must not carry fluids.
 - (vi) The frame must not unduly impede the entry or exit of the driver and co-driver/navigator. Two points of exit from the vehicle are required. These must have unimpeded access for the crew, and at least one must be able to be used if the vehicle were to be on its side or upside down. The crews must be able to exit the vehicle within 10 seconds.
- (l) Where an occupant's helmet may come into contact with the frame, non-flammable high-density padding shall be provided for protection, which complies with one of the following:
 - (i) International competition and below, FIA standard 8857-2001, type A (see FIA Technical List No 23 "Roll Cage Padding Homologated by the FIA") or;
 - (ii) For national competition and lower, SFI specification 45.1.
- (m) Body Protection: Where the body of an occupant could come into contact with the safety cage, it is recommended that flame retardant padding be fitted. FIA standard 8857-2001 or SFI specification 45.1 padding is recommended.
 - (i) Padding complying with FIA specifications is recommended.
- (n) Guidance on welding: All welding must be of the highest possible quality with full penetration and preferably using a gas shielded arc.

- (i) Although good external appearance of a weld does not necessarily guarantee its quality, poor-looking welds are never a sign of good workmanship.
- (ii) When using heat-treated steel the special instructions of the manufacturers must be followed (e.g., special electrodes, gas protected welding).
- (iii) It must be emphasised that the use of heat-treated or high carbon steels may cause problems and that bad fabrication may result in a decrease in strength (caused by brittle heat-affected zones) or inadequate ductility.

9.2 MANDATORY TUBES

(a) Each frame shall incorporate at least the following bars/tubes

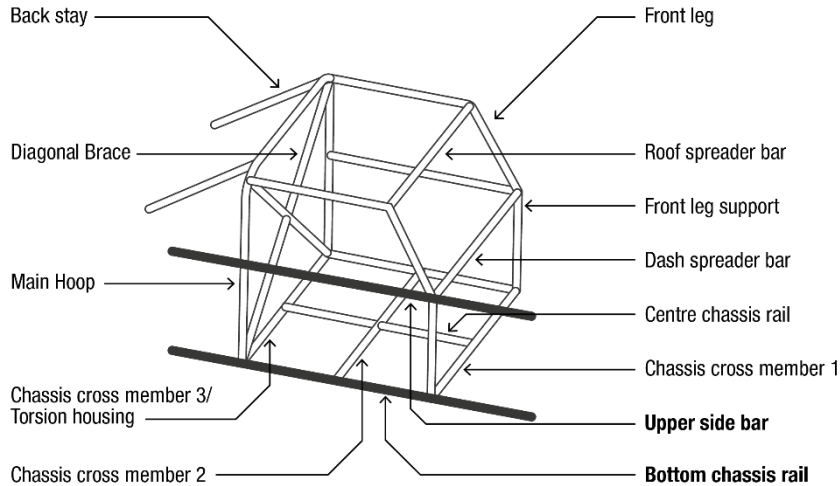

Diagram 2.1a

- (i) A main hoop with two diagonal braces.
 - (A) where a transverse main hoop is used it must be a continuous length of tube (refer diagram 2.1a), or
 - (B) where a lateral main hoop is used the front leg combined with the backstay shall form a continuous tube (refer diagram 2.1b).
- (ii) An upper side bar (“hip rail”) on both sides of the frame, of dimensions meeting the minimum tube size outlined in Article 9.9, Materials, positioned not less than 450mm from the lowest part of the bottom chassis rail to topmost part of the upper side bar, measured vertically at the midpoint between the main hoop and front leg (refer diagram 2.1b)

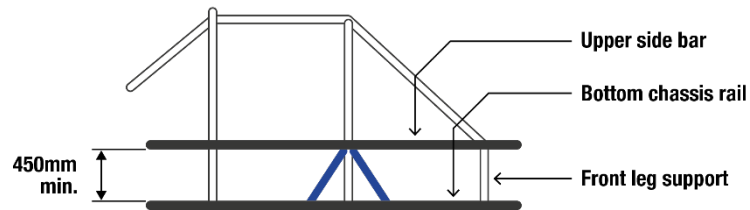

Diagram 2.1b

- (iii) A bottom chassis rail on each side of the automobile.
- (iv) A centre chassis rail. (alternative designs may be acceptable, refer article 9.3 (a) & (c).
- (v) A front leg on each side of the automobile which extends from the main hoop to the upper side bar and must be supported by a vertical tube (+or- 10°) directly below the intersection of upper side bar and front leg. Refer Diagram 2.1b.

- (vi) If fitted (refer article 9.7) the front leg shall be supported by a vertical tube at the top windscreen bend and the upper side bar. The tube may be supported, below the upper side bar, by a straight bar or a "V" bar. Refer Diagram 2.1b.
 - (vii) A chassis cross member is required in three locations:
 - (A) base of the main hoop;
 - (B) approximately half way between the main hoop and the front leg; and
 - (C) between the front legs.
 - (viii) A longitudinal brace mounted near the roof line and near the top of each outer bend of the main hoop. Longitudinal braces must make an angle of 30° or more to the vertical.
 - (ix) A dash spreader bar.
 - (x) A roof spreader bar.
- (b) Omissions or design variations to the Minimum Design Requirements are not permitted unless noted by Motorsport Australia as an acceptable alternative, or as an alternative which requires Motorsport Australia Safety Cage Certification and the vehicle is subject of such certification.

9.3 Acceptable alternative designs/method of construction:

- (a) Two or more chassis "centre" rails are permitted or Motorsport Australia may consider alternative configurations which achieve a similar outcome in strengthening the floor area of the chassis.
- (b) A torsion bar housing may replace the chassis cross member at the base of the main hoop, and if so, this tube need not comply with the material requirements outlined in this regulation.
- (c) A transmission "tunnel" may be constructed providing that it incorporates the required cross members. These may be detachable, providing they are constructed as a demountable joint in accordance with Schedule J of the Motorsport Australia Manual.
- (d) Additional bars are permitted in all areas other than the window openings, which shall be as per Article 9.6c.
- (e) Compulsory reinforcement within the Main Hoop must include at least one continuous member, be it a horizontal member or one of the diagonal members where they are fitted OR where a lateral roll bar is used the same shall apply for reinforcement in the area required.
- (f) Main hoop reinforcement variation: the following variations to the diagonal braces in the main hoop are acceptable:

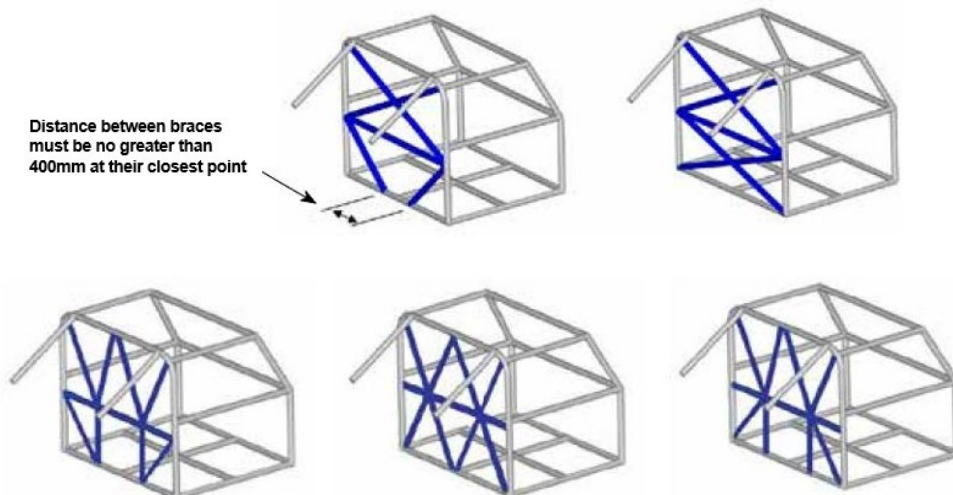

9.4 Front chassis section

A substantial structure is to be built into the front section of the vehicle which shall protect the crew in the case of a frontal impact. This structure shall incorporate at least four longitudinal tubes of at least 38mm x 2.5mm, of one of the approved frame tube materials.

9.5 Rear chassis section

Each back stay must be supported by substantial framework constructed of the same material as the

mandatory tubes. Refer also to Article 9.9

9.6 OPTIONAL TUBES

- (a) Side protection options: The use of one the following side protection options is suggested as a minimum.

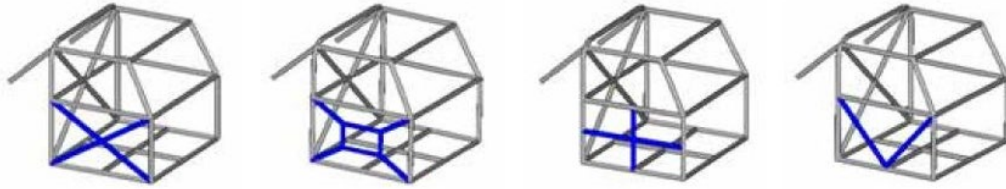

- (b) Roof and rear stay bracing options:

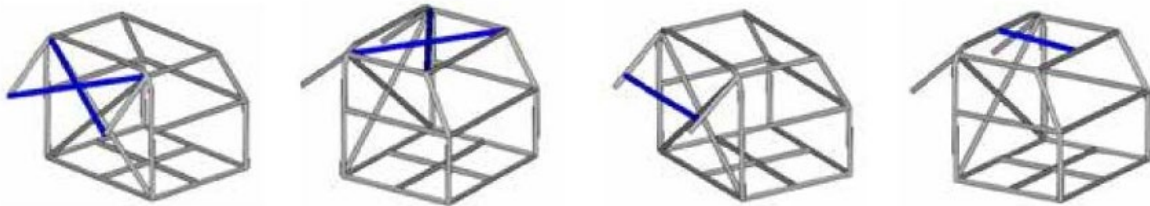

NOTE: A single tube in either direction is also acceptable as an alternative to the “X” option in the roof area.

- (c) Front window opening bracing options:

NOTE: An “X” is not permitted in the front window opening.

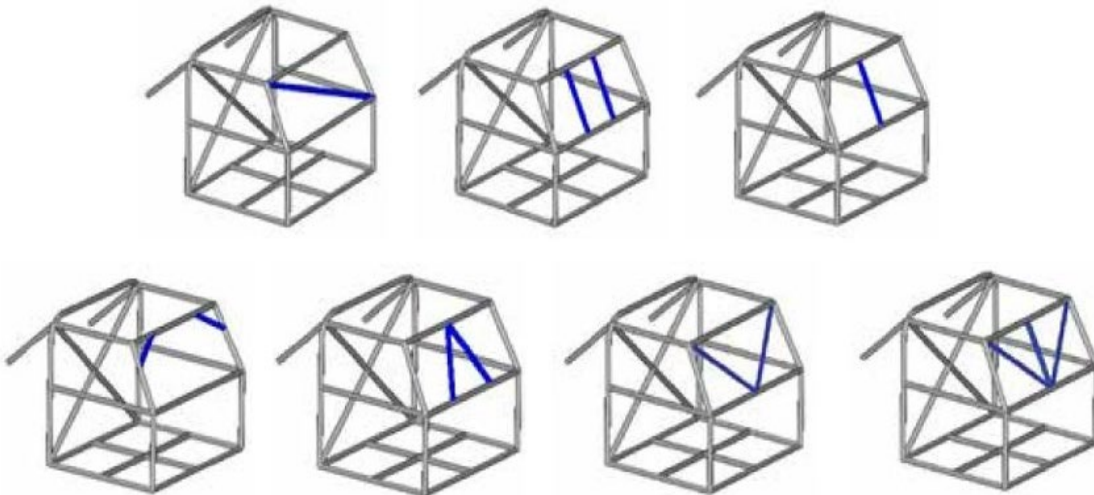

9.7 OTHER COMPULSORY TUBES

Compulsory roof reinforcement for Buggies: Roof reinforcement in accordance with one of the following designs is mandatory for all buggies.

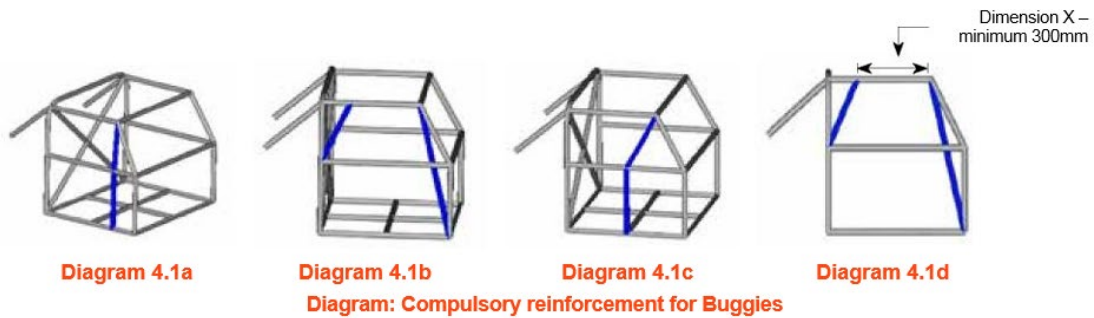

NOTE: The roof reinforcement bars depicted in diagram 4.1b shall be fitted with a minimum of 300mm between the two bars at their highest point (Dimension 'X') in accordance with Diagram 4.1d. The left side reinforcement bar is not depicted in order to improve the clarity of the diagrams, but its installation is a requirement.

9.8 ALTERNATE SIDE PROTECTION:

(a) Where a frame does not comply with the requirement outlined in Article 9.2(ii) in its original configuration, additional side protection members shall be added in accordance with one of the following options:

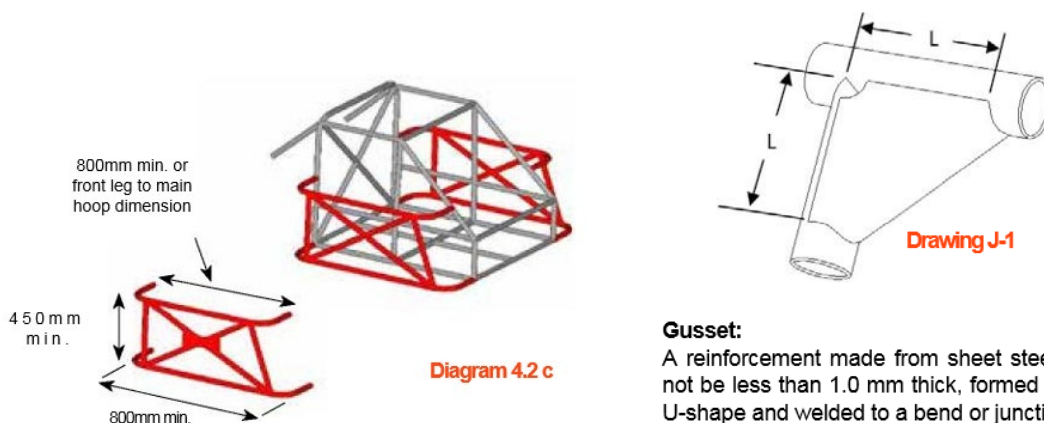
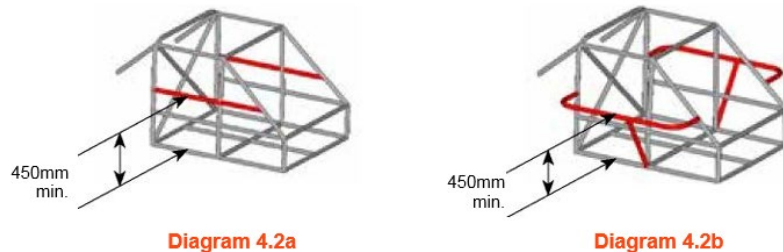

Gusset:

A reinforcement made from sheet steel of not be less than 1.0 mm thick, formed to a U-shape and welded to a bend or junction.

The dimension (L) shall be between two and four times the diameter of the larger of the tubes joined.

(b) The side protection structure shall be no less than 800mm in length at both the upper side rail and bottom chassis rail unless the front leg to main hoop dimension where the structure is attached is less, in which case that dimension shall be the minimum. Minimum tubing dimensions: 38mm x 2.5mm

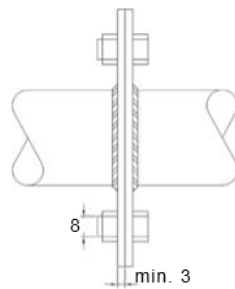

All dimensions in mm

Diagram 4.2d

Refer to article 6, Materials, for material specifications. The lower side protection bar shall be attached to the bottom chassis rail. A structure to this design may take the place of a nerf bar, if the structure also complies with the requirements for a nerf bar.

- (c) Any of the following methods of attachment may be utilised:
- (i) Welding
 - (ii) Sleeved joiner welded to the frame, additional framework attached on the frame by at least one grade 8.8, 10mm bolt.
 - (iii) Refer Drawing J-54 or J-55 in the Motorsport Australia Manual, Schedule J, Safety Cage Structures.
 - (iv) Bolted flanges. Each flange with a minimum area of 100cm² shall be at least 3mm thick (minimum 6mm total when two flanges are butted together). The additional framework shall be attached by at least two grade 8.8, 8mm bolts at each flange attachment.
- (d) The design detailed in Diagram 4.2c shall consist of an upper and lower bar and shall include a reinforcing cross design utilising either two uninterrupted tubes joined by a gusset at the cross (preferred), or a 'conventional' cross design where one of the tubes is cut and welded to the uninterrupted tube (in which case gusseting of this join is recommended).
- (e) Additional guidance on fitment: While minimum standards have been set, each competitor should consider the rationale for this requirement and design the side protection structures of the vehicle to provide as high a level of protection practicable.
- (f) 450mm has been set as a minimum dimension between the bottom chassis rail and upper side bar. Due to the varying configuration of each automobile, in particular the height the seat is mounted, it would be appropriate in some circumstances for the upper side bar to be fitted higher. Each competitor should consider their own vehicle's configuration and fit the bar (including any additional reinforcement) in such a way so as to afford the best compromise between protection and crew exit space.
- (g) In accordance with Article 1, adequate space to exit the vehicle must be maintained. This may be achieved by moving the side protection structure further outboard from the existing frame structure.
- (h) Key to diagrams
- (i) Red: structure added to comply with Diagram 2.1(b)
 - (ii) Blue: recommended tube to be considered for the provision of additional strength
 - (iii) Grey: minimum requirements of Article 9 prior to 1 January 2010

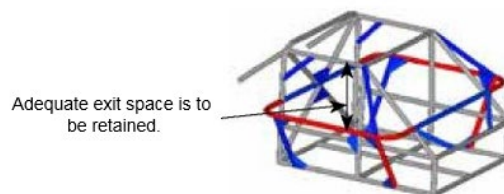

Diagram 4.2e

- (i) Recommended reinforcement for consideration: Extra bars may be added for increased strength. Additional gusseting or support tubing is recommended where the upper side bar does not align with existing tubing on the same plane. Gussets may be added to all welded tube joints as depicted in Diagram 4.2e and 4.2g.
- (j) The following diagrams depict some potential additions for the consideration of competitors.

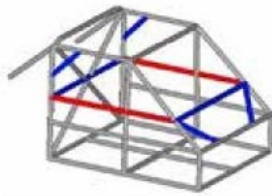

Diagram 4.2f

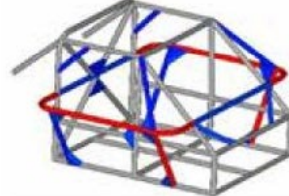

Diagram 4.2g

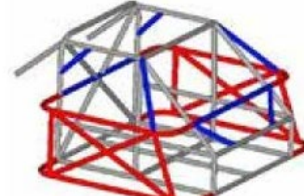

Diagram 4.2h

- (k) It is the vehicle owner's responsibility to ensure a chassis number is present on the vehicle and that it is legible and viewable without the need for dismantling. Where the vehicle does not come from a manufacturer with a chassis number, one shall be applied (e.g., by stamp, welded, attached plate) to the frame in a location unlikely to be damaged. In such cases it is recommended the chassis number match the log book number.

9.9 MATERIALS

- (a) Minimum specification of material used in the construction of frames shall be:
- (i) As specified in Article 8 of Schedule J (recommended) or;
 - (ii) High carbon heat-treated steel (e.g., chromoly) with a minimum ultimate tensile strength of 600MPa or;

Material dimensions:

Tube Title	Tube OD	Wall Thickness	Comment
------------	---------	----------------	---------

Material complying with Schedule J, Article 8.

Diagonal Brace	38mm	2.5mm	
Upper Side Bar	38mm	2.5mm	To be installed between the main hoop and each front leg. The upper side bar shall be a continuous length unless it attaches to a roof reinforcement bar with dimensions of at least 38mm x 2.5mm, in which case it may be installed in two parts.
Main hoop	38mm	2.5mm	
Main hoop	44.45mm	2.5mm	A vehicle that is subject to a logbook from 1 January 2019 and has a minimum weight of greater than 1400 Kg the main hoop must be OD 44.45 x 2.5 thickness whether it is a transverse or lateral main hoop.
Chassis and centre chassis rail	38mm diameter or 40 x 40mm RHS	2.5mm	
Compulsory Cross X-members 1, 2 & 3	38mm diameter or 40 x 40mm RHS	2.5mm	
Spreader Bars: 1. Roof 2. Dash	38mm	2.5mm	
Backstays	38mm	2.5mm	If not part of main hoop
Front legs	38mm	2.5mm	If not part of main hoop

Roof reinforcement	25mm	1.6mm	Minimum dimensions – refer also to “implementation”
Roof reinforcement	38mm	2.5mm	A vehicle that is subject to a logbook from 1 January 2019

Alternative Tubes – The following tube sizes are minimum dimensions and may be used as alternatives to 38 x 2.5 CDS/CDW and 44.45 x 2.5mm accordingly.

High carbon heat-treated steel tubes	38mm	2.4mm	All regulated tubes must be to the same specification and meet the minimum dimensions outlined in this table.
	44mm	2.4mm	All regulated tubes must be to the same specification and meet the minimum dimensions outlined in this table.

Alternative Tubes Requiring Homologation by Motorsport Australia*

High carbon heat-treated steel tubes	Less than 38mm	Less than 2.4mm	All regulated tubes must be to the same specification and dimensions.
---------------------------------------------	----------------	-----------------	-----------------------------------------------------------------------

***NOTE:** The structure shall be required to withstand the prescribed test loads to the main hoop, the front leg and the harness mount/s, the details of which are available from the Motorsport Australia Technical Department. This must be certified by a qualified engineer acceptable to Motorsport Australia who is either FIA approved (refer FIA Technical List No. 35) or is a member of the Royal Aeronautical Society or Institute of Engineers Australia (MIEA). The base used for the load will be the bottom of the main hoop and the front leg tubes.

NOTE: Tubing not forming part of the structure of the frame governed by this regulation (e.g., suspension mounting points), is not required to conform to these specifications.

10. WINDOWS

- (a) All window glass may be removed or replaced by another suitable material e.g., polycarbonate. Windscreen and front door windows must be clear, save for production tinting.
- (b) Vehicles fitted with full windscreens must be fitted with windscreen washers and an effective windscreen wiper in the driver’s line of vision.

11. FIRE EXTINGUISHER

Each vehicle must be equipped with one or more hand-held fire extinguisher/s complying with Schedule H (refer “General Requirements for Cars and Drivers”).

12. SEATS

- (a) There must be at least one seat for each occupant which must be capable of being occupied over a minimum width of 350mm. Seats may be disposed laterally or longitudinally. Seat bases must be protected by a suitable floor pan or skid plate see item 3(a) of adequate strength.
- (b) Head restraints are required to be fitted for each seating position. Each restraint, if not incorporated into the seat, must consist of a metal backing plate at least 2mm thick and not less than 225cm² in area, together with a resilient padding at least 25mm thick. The restraint shall be attached by welding or other suitable means and have no protrusions into the padded area. With the occupant seated in the normal position, the top of the restraint or seat shall be no lower than the centre of the helmet and no further than 50mm from the helmet.

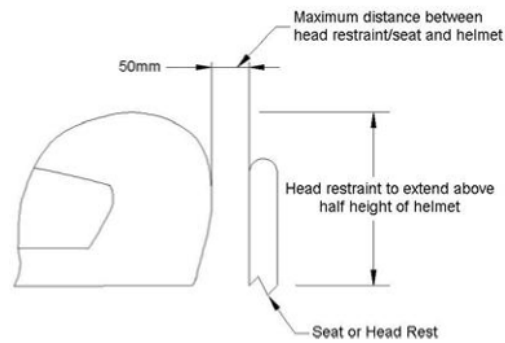

- (c) The minimum width of the foot space for each occupant is 250mm measured at the level of the pedals along a horizontal line at right angles to the longitudinal axis of the chassis.

13. ROOF

- (a) The height of the roof on each automobile must be at least 850mm measured from the lowest part of the uncompressed seat cushion vertically and coincidentally with the centre line of each seat. The roof must be at least 50mm above the occupants' helmets when they are seated normally.
- (b) All open automobiles must be fitted with roof plates of the following specifications: Length: at least 600mm so displaced that at least 300mm will be forward of the driver's forehead when seated in the vehicle.
- (c) Width: is determined by the position of the longitudinal braces of the safety cage structure; the plate shall span the gap from one to the other.
- (d) Mounting: shall be by welding to frame, bolting with \varnothing 6 bolts or using 1/4-turn steel fasteners to tabs at intervals not greater than 300mm; or by hinge/s. The drilling of holes in any part of the safety cage structure to facilitate the mounting of the roof is not permitted. Minimum size for 1/4 turn fasteners is 3/8".
- (e) Material: may be of aluminium (at least 2.6mm (12g)) or steel sheet (at least 1.2mm (18g)).
- (f) In addition to the above, any hinged roof plate shall comply with the following:
- (i) The plate must be attached along its front edge by a continuous hinge which extends across the width of the roof to within 20mm of the side tubes.
 - (ii) The minimum acceptable hinge is 50mm continuous type with a steel pin of at least 2.5mm diameter.
 - (iii) Both side and rear outside edges must overlap, and be supported by, the roll cage structure.
 - (iv) Attachment of the hinge to the roof panel must be at intervals not greater than 30mm. The minimum acceptable fixing device is a 3mm diameter steel or Monel rivet.
 - (v) The hinge must be attached to a mounting plate, which must be integrated with the front hoop. Attachment of the hinge to this plate must comply with sub-paragraph (iv) above.
 - (vi) At least two self-locking latches, suitable for securing the roof panel closed, are required. Catches must be free of any sharp or protruding edges.
 - (vii) Pop rivets used are to be corrosion resistant e.g., Monel metal.
 - (viii) For each automobile fitted with an opening roof:
 - (A) Each occupant shall be required to have a wrist/arm restraint on each arm.

14. BONNET

If fitted with rear hinged bonnets and/or panels there must be at least two independent systems of adequate strength and limited extensibility which simultaneously hold each panel completely closed.

15. BRAKES

- (a) Primary braking: Vehicles are required to be fitted with brakes controlled by a foot pedal operating simultaneously on four wheels.

- (b) Emergency braking: the provision of an operable and effective hand brake is compulsory unless the car is fitted with a dual circuit braking system.
- (c) The use of copper brake lines is prohibited.

16. STEERING

- (a) Steering column locks on any automobile not registered for use on public roads must be removed or rendered inoperative.
- (b) Any production vehicle manufactured after 1 July, 1971 must be fitted with a steering column which complies with ADR 10A or 10B. All other vehicles that are fitted with a steering column must incorporate at least two universal joints, the shafts of which are offset to ensure collapsibility.

17. RADIO

The carrying of equipment providing radio communication between vehicles and pit or service crews is permitted.

18. SAFETY CAGE STRUCTURE

- (a) Other than those complying with Article 9, each vehicles must be fitted with a safety cage structure, as specified in Schedule J (refer "General Requirements for Cars and Drivers").
- (b) The top of the main roll bar (hoop) cages must be at least 50mm above the occupants' helmets.
- (c) Each automobile in UTV, Extreme 2WD, Performance 2WD, Production 4WD and Extreme 4WD is permitted the use of front window opening bracing options as shown in Article 9.6 (c).
- (d) An automobile in Extreme 2WD, Performance 2WD, and Extreme 4WD is permitted the use of flexible lug mounts which can be fitted at either end of the back stay of the safety cage structure to join the backstay to the chassis/frame, only where the vehicle chassis is separate to the bodywork, and must conform to the following minimum specifications:

Outer Sleeve

Material:		Same as used for a backstay or superior and welded to the end of a backstay
Wall thickness:		2.5mm minimum
Outside diameter:	Min: Max:	Same as used for a longitudinal brace 25% larger than OD of a longitudinal brace
Length:	Min:	Same as OD of rear brace

Busing Material

Material:		Rubber, urethane, nylon or similar flexible material
Outside diameter:		No greater than three and a half times the OD of the inner sleeve and must fit firmly into the outer sleeve
Length:	Min:	Same as length of outer sleeve

Inner sleeve/spacer tube

Material:		Steel.
Wall thickness:	Min:	1.0mm
Inside diameter:		Must "match" OD of the cross bolt.
Length:	Min:	No greater than the length of the bushing material, and at least 2mm longer than the outer sleeve.

Cross bolt

Diameter:	Min:	11.0mm or 7/16"
Grade:	Min:	8.0 or 8.8

Mounting lugs

Material:		Steel flat bar.
Thickness:	Min:	5.0 mm
Width/height:	Min:	Not less than the OD of the outer sleeve.

19. WINDOW NETS AND WRIST/ARM RESTRAINTS

- (a) All vehicles must be equipped (for each occupant) with safety nets or wrist/arm restraints, each properly attached, which ensure that each arm of each crew member cannot project beyond the line of the bodywork of the vehicle. If wrist/arm restraints are fitted they must be worn at all times whilst the automobile is moving in competition. Each window net and/or wrist/arm restraint must comply with Motorsport Australia Schedule I.
- (i) **Wrist/Arm restraints:** must be mounted on one end to the safety harness lap belt and the other end to each arm or wrist.
- (ii) **Window Net:** must cover each opening of the cockpit, except for the forward window, and:
- (A) forward to the centre of the steering wheel; and
- (B) be able to withstand a load of 500N applied at any point.

20. SEAT BELTS

A Type A full harness seat belt complying with the requirements of Schedule I (refer "General Requirements for Cars and Drivers") must be fitted and worn by each occupant during competition. A crotch restraint which effectively prevents the lap belt from riding up the wearer's body must be fitted.

21. EMERGENCY & FIRST AID (NOT APPLICABLE TO STADIUM RACING)

- (a) Each vehicle shall carry on board:
- (i) One standard warning triangle of 200mm sides, for use in case of breakdown or accident,
- (ii) An OK/SOS sign (long course only)
- (iii) An effective tow rope of at least 5m length
- (iv) A commercially-available seat belt cutting device for each occupant that is securely mounted within reach of that occupant but removable without the use of tools and of a design that poses no cutting risk to the occupants.
- (b) All vehicles are required to carry on board a weatherproof emergency kit, containing at least the following:

2 x extra-large universal accident dressings	6 x safety pins	2 x sterile eye pads
2 x large open weave bandages	1 x thermo accident blanket	1 x First Aid manual
2 x medium open weave bandages	2 x medium combination pads	1 x large burn dressing with a non-adhesive surface
1 x pair dressing scissors	6 x adhesive plaster strips	
1 x roll adhesive tape	1 x triangular bandage	

NOTE:

- (i) These items may be purchased from St John Ambulance as a kit or from any reputable first aid supply company.

- (ii) This kit is no substitute for first aid training. It is recommended that all competitors should undertake a first aid training course.
- (iii) It is recommended that eyewash, burn cream and trauma shears are included in the pack.

22. AERODYNAMIC DEVICES

Any air dam fitted to the front of a vehicle may not exceed the width of the original coachwork at the front and must not project forward beyond the line of the original coachwork. An aerodynamic device in the form of an aerofoil section may be fitted to an automobile of Pro, Prolite, Sportlite, Super 1650, Sportsman, Extreme 2WD or Extreme 4WD class subject to the following conditions and restrictions:

- (a) The surface area of neither the top nor the underside of the aerofoil may exceed one square metre, and the device must not extend beyond the maximum width of the coachwork.
- (b) End plates may not exceed twice the maximum depth of the aerofoil sections, nor may they exceed the maximum length of the aerofoil section.
- (c) Any part of the automobile which has an aerodynamic influence on the stability of the vehicle shall be mounted on the entirely sprung part of the automobile, shall be firmly fixed and shall not be capable of adjustment whilst the automobile is in motion.
- (d) No element of any aerodynamic device shall extend rearwards of the rearmost element of the coachwork/ chassis.
- (e) The highest point of any aerodynamic device shall not be greater than 300mm above the highest point of the coachwork.
- (f) Where the roof comprises an aerofoil section yet is clearly the roof of the automobile:
 - (i) the total area of both of the side sections of the roof may not be greater than 25% of the area of the upper surface of the roof; and
 - (ii) no separate or additional aerofoil may be fitted to the vehicle.

23. EXHAUST

- (a) Each exhaust outlet must be pointed rearwards or sideways. Any exhaust orifice shall not be less than 100mm above the ground and may not project more than 150mm beyond the rearmost portion of the automobile. The exhaust orifice must be located aft of a vertical plane passing through the midpoint of the wheelbase. The orifice may not project beyond the maximum width of the bodywork, nor terminate more than 50mm within the projected plan of the bodywork. Exhaust gas shall only exit at the end of the system. Adequate protection shall be provided to prevent heated exhaust pipes from causing burns.
- (b) If Supplementary Regulations stipulate the requirement for a spark arrestor, then such spark arrestor shall be required to comply with either AS1019 – 1970 or alternatively hold USDA Fire Service Approval.
- (c) Each exhaust shall be configured such that the sound emitted when measured 30m from the track edge does not exceed 95dB(A) unless event regulations set a lower limit.

24. LIGHTING

- (a) Each vehicle must be fitted with at least one rearward facing red stop lamp. Each rearward facing stop lamp shall only be operated by the application of the foot brake.
- (b) Each vehicle must be fitted with at least one rearward facing amber lamp, and wired so that it operates at all times when the main power is switched on. No other switch is permitted in the circuit for a rearward facing amber lamp.
- (c) Each vehicle in the Sportsman, SXS Sport, Super 1650 and Production 4WD (optional for all other classes) must be fitted with at least one rearward facing blue strobing and/or flashing light which is wired so that it operates at all times when the power is switched on.
- (d) Each rearward facing lamp shall be:
 - (i) visible when viewed from up to a 45° angle in each rearward direction and from the side of the vehicle longitudinal centre line;
 - (ii) fitted with a minimum of one lens or a maximum of two lenses totalling a minimum area of 60cm²;

- (iii) Equivalent to a minimum of a 21 watt incandescent globe.
 - (iv) mounted not lower than 200mm below the highest point of the vehicle not including an aerial, roof fin or number plate; and
 - (v) fitted on or into the bodywork so that every part of the lens is external to the bodywork.
- (e) A penalty of disqualification shall apply for any action which inhibits the operation of any rearward facing lamp whilst the ignition is on, in addition to any other penalty which may be imposed by the Stewards.
- (f) Each vehicle must have a minimum of a single white forward facing headlamp fitted which comply as a minimum with ADR 46 for a dipped-beam headlamp and which must be illuminated during all competitive sections of the event.

25. BATTERY AND BATTERY MARKER

- (a) The battery must be securely attached to the body or chassis and effectively covered so as to prevent spillage, even in the case of inversion.
- (b) There shall be attached to the coachwork a 150mm blue triangle marker indicating the location of the battery.
- (c) A battery isolation (master) switch shall be fitted to each vehicle which effectively isolates all electrical circuits from the battery and stops the engine.
 - (i) Rallysafe units are exempt from article 25(c) and may have constant power in accordance with manufacturer's fitting instructions.
- (d) It shall be located in an area where it is capable of being operated by the seated driver and co-driver. Where the switch is not readily accessible from outside, a switch or remote means of operating the switch (e.g., pull cable) shall be located in the vicinity of the base of the right hand side "A" pillar. The position of this switch shall be marked clearly by a symbol showing a red spark in a white-edged blue triangle on the exterior of the vehicle.

26. WARNING DEVICE

Vehicles must be fitted with an effective audible warning device sufficient in volume to ensure that an automobile being overtaken is aware of the presence of the overtaking vehicle.

27. FUEL AND FUEL FITTINGS

- (a) Only Commercial Fuel and Unleaded Racing Fuel as defined by Motorsport Australia in Schedule G (refer "General Requirements for Cars and Drivers") may be used. The use of AvGas/Leaded Racing Fuel is specifically prohibited.
- (b) All fuel lines and hoses passing through the passenger compartment must be made of metal, braided neoprene, or other Motorsport Australia-approved material.
- (c) For all automobiles with electric fuel pumps, the power supply to all such fuel pumps must be cut off after a maximum of six seconds absence of crankshaft revolution, in accordance with the provisions of Schedule C, Article 10 (refer "General Requirements for Cars and Drivers").

28. DIESEL ENGINES

The effective engine capacity of a supercharged diesel engine will be calculated as the product of the swept volume multiplied by a factor of 1.5.

29. WHEELS AND TYRES

- (a) The number and/or size of wheels is free provided that there are at least four, not in a line, or, if an all-terrain vehicle, three in triangular formation.
- (b) Wire spoke wheels are specifically prohibited.
- (c) Wheels of width greater than 13" must be fitted with tyres which are mechanically located.
- (d) Tyres may be re-worked, provided that the depth of the resultant tread pattern does not intrude into the original undertread rubber. The lack of a tread pattern is not necessarily a ground for rejection by scrutineers; but any tyre considered unsafe will be rejected.

- (e) All tyres must be fitted with tubes, unless they are specifically designed for use without tubes. All valves must be fitted with metal caps. Valve stems shall not protrude beyond the outer edge of the tyre profile.
- (f) Automobiles must be so constructed that when both tyres on the same side of the automobile are deflated, no part of the automobile touches the ground.

30. NUMBERS

- (a) In all events the competition number must be displayed on each side of a panel carried so that the base of the panel is not below the level of the roof at its highest point. Such panel shall be parallel to the longitudinal axis of the automobile, vertical, white, and provide a space at least 25mm between each numeral of the number, and between each number and the edge of the panel.
- (b) The number must also be displayed on the rear of the automobile.
- (c) All numbers must be displayed in horizontal format, be at least 150mm height, with at least 19mm stroke width and be black in colour on a white background, except for a State Championship where the State Champion in each class shall display their vehicle number on a yellow background. They shall otherwise comply with the provisions of Schedule K (refer "General Requirements for Cars and Drivers").
- (d) All vehicles competing in Open events shall have competition numbers allocated by Motorsport Australia. Apart from in stadium races, the first digit/s of these shall denote the class of the vehicle, save that the Australian Champion may use the number "1"; 2nd and 3rd placegetters may use "2" and "3" respectively.
- (e) The first three competition numbers in each class (i.e.; 101, 102, 103, 201 etc.) are reserved for the exclusive use of the first three drivers in the preceding year's AORC; and the normal registered competition numbers used by these competitors will be held for them for the following year.
- (f) The use of any competition number ending with two or more zeros is not permitted.
- (g) Event organisers may require the competition number to be affixed in such other position/s as may be specified in event regulations.
- (h) The Motorsport Australia competition numbers for each class are as follows:

Class	Competition Numbers	AORC Reserved Numbers
Pro Buggy	01, 02, 03, 4 - 99 and 901 - 999	01, 02, 03
Prolite Buggy	101 – 199	101, 102, 103
Super 1650	201 – 299	201, 202, 203
Sportsman	301 – 399	NA
Extreme 2WD	401 – 499	401, 402, 403
Performance 2WD	501 – 599	501, 502, 503
SXS Pro Turbo	601 – 699 and 6101 - 6199	601, 602, 603
SXS Sport	6601 – 6699	6601, 6602, 6603
Production 4WD	701 – 799	701, 702, 703
Extreme 4WD	801 – 899	801, 802, 803
Sportslite	1001 – 1099	1001, 1002, 1003
Extreme Lite Buggy	1101 – 1199	NA
Off Road Kart	1201 – 1299	NA
Classic Off Road	1301 - 1399	NA

31. ADDITIONAL REQUIREMENTS

In addition to Articles 1-30, and where specifically required by event regulations, vehicles may be required to comply with any or all of the following additional requirements:

31.1 CATCH TANK

If fitted with a crankcase breather/s discharging to atmosphere, have fitted to such breather/s an oil trap container (which must be empty at the start of the competition), of at least two litres capacity (for cars of up to 2000cc) or three litres (for cars of over 2000cc).

31.2 WIRE LOCKING

Be fitted with locking or wiring devices which prevent the loosening of any oil drain plug/s.

31.3 AERIAL

In events conducted in sand dunes, be fitted with an aerial of not less than 4m height, to which is attached a red flag of not less than 600cm² in area.

31.4 ADDITIONAL LIGHTING

Be fitted with additional specified lighting equipment.

31.5 MUDFLAPS

Be fitted with effective mudflaps of suitably rigid material behind each driven wheel, the rear wheels and immediately behind the front wheels if they are driven. When the vehicle is viewed from the rear, the mudflaps shall, in conjunction with any mudguard fitted, completely obscure the tyre profile to within 80mm of the ground. For events run entirely on sand, neither mudguards nor mudflaps are required.

OFF ROAD

GENERAL REQUIREMENTS

MODIFICATIONS APPLICABLE 2023

28. **DIESEL ENGINES CAPACITY**

~~The effective engine capacity of a supercharged diesel engine will be calculated as the product of the swept volume multiplied by a factor of 1.5.~~

The nominal engine capacity is subject to the relevant multiplication factors in accordance with the *Manual – Classification of Automobiles*.